

Section  
8



# THE ROBOT

## Table of Contents

<b>8 THE ROBOT .....</b>	<b>2</b>
8.1 OVERVIEW .....	2
8.1.1 What is a <i>FIRST</i> Robot? .....	2
8.1.2 Getting Started.....	2
8.1.3 Related Documents & Resources.....	3
8.1.4 Conventions.....	3
8.2 DEFINITIONS .....	3
8.3 ROBOT RULES .....	6
8.3.1 Safety & Damage Prevention .....	8
8.3.2 General Robot Design .....	11
8.3.3 Budget Constraints .....	14
8.3.4 Fabrication Schedule .....	15
8.3.5 Material Utilization .....	17
8.3.6 Power Distribution.....	19
8.3.7 Motors & Actuators .....	21
8.3.8 Control, Command & Signals System .....	22
8.3.9 Pneumatic System.....	26
8.3.10 Operator Interface.....	28
8.3.11 Robot Inspection.....	29
8.4 PARTS USE FLOWCHART.....	29

## 8 THE ROBOT

### 8.1 OVERVIEW

This section of the 2008 *FIRST* Robotics Competition Manual provides rules applicable to the design and construction of the 2008 ROBOT. ROBOTS will be inspected at each *FIRST* Robotics Competition event to verify rules compliance before being allowed to compete.

**COMPLIANCE WITH ALL RULES IS MANDATORY**

#### 8.1.1 What is a *FIRST* Robot?

A *FIRST* robot is a remotely operated vehicle designed and built by a *FIRST* Robotic Competition team to perform specific tasks when competing in the 2008 competition “*FIRST* Overdrive.”

#### 8.1.2 Getting Started

Please be sure to thoroughly read and understand Sections 4, 6, 7, 8, and 9 of this manual before designing your ROBOT. In particular, pay attention to **Section 8.3.1. General Design & Safety Rules** and **Section 8.3 Robot Rules** before proceeding. The following are just a few important points offered to help teams in getting started:

1. Evaluate the Game's physical challenges and identify those that the robot will have to overcome.
  - Will it have to climb, pick and place items, push / pull objects or robots, possess a low profile, extend its height, lift items, hang, etc.?
  - What are the game's implications regarding the ROBOT'S center of gravity?
  - Are unique field surface characteristics important when determining robot driving mechanism design?
  - Are there any particular offensive / defensive capabilities important to the ROBOT?
2. Inspect all items provided in the 2008 Kit Of Parts (KOP CJEC) and review their basic features. Note that suppliers' data sheets are referenced in the Kit Of Parts tables for many of the components in the kit.
3. We recommend that you carefully read the documents listed in **Section 8.1.3 Related Documents & Resources**.
4. Look over the specifications and technical notes provided for the various Kit Of Parts components.
5. Note all safety rules relating to the robot's design. They include:
  - The locations and ratings of circuit breakers where indicated in the wiring diagrams
  - Wire size
  - Stored energy guidelines
  - Attention to sharp corners and edges
  - Shields for moving parts and pinch points

### 8.1.3 Related Documents & Resources

In addition to this chapter, other sections in this manual and other documents should be reviewed before proceeding with the robot design process. Note, unless otherwise specified, that all referenced documents are available online at [www.usfirst.org/frc/2008/manual](http://www.usfirst.org/frc/2008/manual)

- **Section 6: The Arena, Section 7: The Game and Section 9: The Tournament**
- **Section 4.9.4: Crate Shipping Deadlines** as listed in **Section 4: Robot Transportation**
- **FIRST Guidelines, Tips, and Good Practices**
- Innovation First, Inc. instruction manuals for the *Robot Controller*, *Spike relay modules*, and *Victor 884 speed controllers* as provided by their manufacturer:  
[www.ifrobotics.com/frc-robot-control-system-overview.shtml](http://www.ifrobotics.com/frc-robot-control-system-overview.shtml)
- *FIRST* 2008 Chassis Kit Manual – Information to assemble chassis kit available at:  
[www.ifrobotics.com/kitbot.shtml](http://www.ifrobotics.com/kitbot.shtml)
- *FIRST* 2008 Pneumatics Manual - Valuable information about the pneumatic components and ordering processes are included.
- *FIRST* 2008 Sensors Manual – Helpful information regarding the application, assembly, and programming of the sensors included in the 2008 Kit Of Parts.
- User Guide - *FIRST* IR Learning Infrared Remote Control Decoder Board
- 2008 Robot Power Distribution Diagram
- *FIRST* Official Robot Inspection Sheet - it is strongly recommended that this be used as a guide to pre-inspect your ROBOT before it ships.

### 8.1.4 Conventions

Specific methods are used throughout this section to highlight warnings, cautions, key words or phrases to alert the reader to important information designed to help teams in constructing a robot complying with the rules in a safe and workmanlike manner.

Warnings, cautions, and notes appear in bordered boxes. Key words that have a particular meaning within the context of the 2008 *FIRST* Robotics Competition are defined in Sections 6, 7.2 and 8.2, and indicated in ALL CAPITAL letters throughout this text. References to other sections of the manual appear in ***bold italics***. References to specific rules within the manual are indicated with a bracketed reference to the rule (e.g. “Rule <S01>”). Operating keys, controls, buttons appear in bold capital letters (i.e. **OFF/ON** switch or **RESET** button).

## 8.2 DEFINITIONS

**COMPONENT** – A ROBOT part in its most basic configuration, which can not be disassembled without damaging or destroying the part, or altering its fundamental function.

- Example 1: raw aluminum stock, pieces of steel, wood, etc., cut to the final dimensions in which they will be used on the ROBOT, would all be considered components. Bolting pieces of extruded aluminum together as a ROBOT frame would constitute a MECHANISM, and the collection of pieces would not be considered a COMPONENT.
- Example 2: a COTS (See immediately below) circuit board is used to interface to a sensor on the ROBOT, and it includes the circuit board and several electrical elements soldered to the board. The board is considered a COMPONENT, as this is the basic form in which it was purchased from the vendor, and removing any of the electrical elements would destroy the functionality of the board.

COTS – A “Commercial, Off-The-Shelf” COMPONENT or MECHANISM, in it’s unaltered, unmodified state. A COTS item must be a standard (i.e. not custom order) part commonly available from the VENDOR, available from a non-team source, and available to all teams for purchase.

- Example 1: a team orders two robot grippers from RoboHands Corp. and receives both items. They put one in their store room and plan to use it later. Into the other, they drill “lightening holes” to reduce weight. The first gripper is still classified as a COTS item, but the second gripper is now a “custom part” as it has been modified.
- Example 2: a team obtains openly available blueprints of a drive component commonly available from Wheels-R-Us Inc. and has local machine shop “We-Make-It, Inc.” manufacture a copy of the part for them. The produced part is NOT a COTS item, because it is not commonly carried as part of the standard stock of We-Make-It, Inc.
- Example 3: a team obtains openly available design drawings from a professional publication during the pre-season, and uses them to fabricate a gearbox for their ROBOT during the build period following kick-off. The design drawings would be considered a COTS item, and may be used as “raw material” to fabricate the gearbox. The finished gearbox itself would be a FABRICATED ITEM, and not a COTS item.

FABRICATED ITEM – Any COMPONENT or MECHANISM that has been altered, built, cast, constructed, concocted, created, cut, heat treated, machined, manufactured, modified, painted, produced, surface coated, or conjured into the final form in which it will be used on the ROBOT.

- Example 1: A piece of extruded aluminum has been ordered by the team, and arrives in a 20-foot length. To make it fit in their storage room, the team cuts it into two ten-foot lengths. These would not be considered FABRICATED ITEMS, as they have not been cut to the final length in which they will be used on the ROBOT.
- Example 2: A team designs an arm mechanism that uses gears with a 1/2-inch face width. They order a 12-inch length of gear stock and cut it into precise 1/2 inch slices. They do not bore out the mounting bores in the center of the gears. The slices are now considered FABRICATED ITEMS, as they have been cut to final size, even though all the machining operations (the center bore) may not yet be completed.

FIX-IT-WINDOWS – Designated work periods following the deadline for shipping the ROBOT, or following the close of a regional competition, in which ALL teams may manufacture parts in preparation for future competitions. During the FIX-IT WINDOWS, software for either the ROBOT or Operator Interface may be developed without restriction. Part or all of the team may participate in the work conducted during this period.

FLAG – A colored (red or blue) bicycle flag used to display ALLIANCE assignments during a MATCH. The flag itself is made of a triangular piece of colored plastic or fabric, measuring approximately 9 inches tall by 11 inches long. The flag is mounted at the end of a 1/4 inch diameter fiberglass flagpole, approximately 36 inches long. The flagpole will run through a rubber stopper, which will be sized to fit in the top of the flag holder (as specified in Rule <R17>). The purpose of the stopper is to help prevent the FLAG from becoming dislodged from the flag holder during the MATCH.

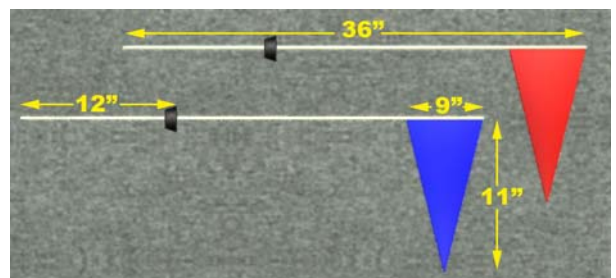

LAP INDICATOR – A FIRST-provided device that is used to automatically record each time the ROBOT CROSSES the FINISH LINE. The LAP INDICATOR is provided to teams at each official competition event. The LAP INDICATOR is attached to the flag pole and must be mounted on the ROBOT as specified in Rule <R18>.

**MECHANISM** – A COTS or custom assembly of COMPONENTS that provide specific functionality on the ROBOT. A MECHANISM can be disassembled (and then reassembled) into individual COMPONENTS without damage to the parts.

**OPERATOR CONSOLE** – the Innovation First-provided Operator Interface unit and any associated equipment, control interfaces, display systems, structure, decorations, etc. used by the DRIVERS to operate the ROBOT.

**PLAYING CONFIGURATION** - The physical configuration and orientation of the ROBOT while playing the game (i.e. after the MATCH has started, and the ROBOT has deployed mechanisms, moved away from the starting location, and/or interacted with the field, GAME PIECES, or other ROBOTS). This configuration is dynamic, and may change multiple times during the course of a single MATCH.

**REPLACEMENT PARTS** – A COMPONENT or MECHANISM constructed as a functional duplicate of an existing part of the ROBOT, for the purpose of replacing a broken or defective part. REPLACEMENT PARTS may be either COTS items or FABRICATED ITEMS. They must be functionally identical to the original part but can be modified to provide more robust performance of the function.

- Example 1: A lever arm made of lexan on your ROBOT breaks. You manufacture a REPLACEMENT PART made of aluminum plate, using the design drawings of the original. As the new part provides the same function as the broken part, the new part is a valid REPLACEMENT PART.
- Example 2: A sensor on the ROBOT is connected to the control system with 24-gauge single-strand wire, and runs across a hinged joint. The flexing of the wire causes it to break, and you want to replace it with 18-gauge multi-strand wire. If the new wire follows the same path as the original and connects only the same devices, then it is a valid REPLACEMENT PART (i.e. it has added robustness without changing function). But if the wire is then used to connect an additional sensor to the same circuit, it is providing a functionally different capability, and is no longer a “replacement.”

**SPARE PARTS** – A COMPONENT or MECHANISM constructed as an identical duplicate of an existing part of the ROBOT, for the purpose of replacing a broken or defective part. SPARE PARTS may be either COTS items or FABRICATED ITEMS, but they must be physically and functionally identical to the original part.

**STARTING CONFIGURATION** – The physical configuration and orientation of the ROBOT when the MATCH is started. This is the state of the ROBOT immediately before being enabled by the Arena Controller, before the ROBOT takes any actions, deploys any mechanisms, or moves away from the starting location. This configuration is static, and does not change during a single MATCH (although it may change from MATCH to MATCH).

**STANDARD BUMPERS** – Bumper assemblies designed to attach to the exterior of the ROBOT within the BUMPER ZONE, and constructed as specified in Rule <R08>. STANDARD BUMPERS may weigh up to 15 pounds, and are excluded from the weight and volume calculations specified in Rule <R11>.

**UPGRADE PARTS** - A COMPONENT or MECHANISM intended to provide additional functionality not currently available on the ROBOT. UPGRADE PARTS may be COTS items or custom FABRICATED ITEMS, and may either add to or replace existing functionality.

- Example 1: A ROBOT is designed with a four-wheel drive system. The system works well on flat floors, but high-centers when trying to drive up steps. The team adds two more wheels on the centerline of the ROBOT to prevent this problem, and the wheels are identical to those

already on the ROBOT. The new wheels would be considered UPGRADE PARTS even though they are the same as the ones already in place, as they alter the functionality of the ROBOT and provide new capability.

VENDOR – A legitimate business source for COTS items that, as a minimum, satisfies the following criteria:

- The VENDOR must have a Federal Tax Identification number. The Federal Tax Identification number establishes the VENDOR as a legal business entity with the IRS, and validates their status as a legitimate business. In cases where the VENDOR is outside of the United States, they must possess an equivalent form of registration or license with the government of their home nation that establishes and validates their status as a legitimate business licensed to operate within that country.
- The VENDOR shall not be a “wholly owned subsidiary” of a team or collection of teams. While there may be some individuals affiliated with both a team and the VENDOR, the business and activities of the team and VENDOR must be completely separable.
- The VENDOR must be normally able to ship any general (i.e., non-*FIRST* unique) product within five business days of receiving a valid purchase request. It is recognized that certain unusual circumstances (such as 1,000 *FIRST* teams all ordering the same part at once from the same VENDOR) may cause atypical delays in shipping due to backorders for even the largest VENDORS. Such delays due to higher-than-normal order rates are excused.
  - Note that the intent here is to protect the teams against long delays in availability of parts that will impact their ability to complete their ROBOT. The *FIRST* Robotics Competition build season is only six weeks long, so the VENDOR must be able to get their product, particularly *FIRST* unique items, to a team in a timely manner.
- The business should maintain sufficient stock or production capability to fill teams orders within a reasonable period during the build season (less than 1 week). Note that this criterion may not apply to custom-built items from a source that is both a VENDOR and a fabricator. For example, a VENDOR may sell flexible belting that the team wishes to procure to use as treads on their drive system. The VENDOR cuts the belting to a custom length from standard shelf stock that is typically available, welds it into a loop to make a tread, and ships it to a team. The fabrication of the tread takes the VENDOR two weeks. This would be considered a FABRICATED ITEM, and the two weeks ship time is acceptable. Alternately, the team may decide to fabricate the treads themselves. To satisfy this criterion, the VENDOR would just have to ship a length of belting from shelf stock (i.e. a COTS item) to the team within five business days and leave the welding of the cuts to the team.
- The VENDOR makes their products available to all *FIRST* Robotics Competition teams.
- VENDORS must not limit supply or make a product available to just a limited number of *FIRST* Robotics Competition teams.
- Ideally, chosen VENDORS should have national distributors.
  - Example distributors include Home Depot, Lowes, MSC, Radio Shack, and McMaster-Carr. *FIRST* competition events are not usually near home. When parts fail, local access to replacements is often critical.

*FIRST* desires to permit teams to have the broadest choice of legitimate sources possible, and to obtain COTS items from the sources that provide them with the best prices and level of service available. The intent of this definition is to be as inclusive as possible to permit access to all legitimate sources, while preventing *ad hoc* organizations from providing special-purpose products to a limited subset of teams in an attempt to circumvent the cost accounting rules.

### 8.3 ROBOT RULES

These rules establish the global ROBOT construction and performance constraints dictated by the characteristics of the provided Kit Of Parts, along with the size and weight design limits. **Compliance with the rules is mandatory! Any ROBOT construction not in compliance with the rules (determined at inspection) must be rectified before a ROBOT will be allowed to compete.**

When constructing the ROBOT, the team is allowed to use the items supplied in the one 2008 Kit Of Parts provided to each registered *FIRST* Robotics Competition team, and additional materials. Many of the rules listed below explicitly address what parts and materials may be used, and how those items may be used. There are many reasons for the structure of the rules, including safety, reliability, fairness, creation of a reasonable design challenge, adherence to professional standards, impact on the competition, compatibility with the Kit Of Parts, etc. When reading these Rules, please use technical common sense (engineering thinking) rather than “lawyering” the interpretation and splitting hairs over the precise wording in an attempt to find loopholes. Try to understand the reasoning behind a rule.

Part of the purpose of the *FIRST* Robotics Competition is to provide team members with the experience of conceptualizing, designing and constructing their own solution to the challenge posed by the game. This must be a consideration when obtaining MECHANISMS and COTS items as additional parts to use on the ROBOT.

This intent is clearly met when a team obtains a MECHANISM or COTS items that was designed for non-*FIRST* purposes, and then modifies or alters it to provide functionality for the ROBOT. For example, if a team obtains a gearbox from a power drill and modifies it to use on the ROBOT, they gain insight into the design of the original gearbox purpose, learn to characterize the performance of the original design, and implement the engineering design process to create their customized application for the gearbox.

However, COTS items that have been specifically designed as a solution to portion of the *FIRST* Robotics Competition challenge may or may not fit within the FRC intent, and must be carefully considered. If the item provides general functionality that can be utilized in any of several possible configurations or applications, then it is acceptable (as the teams will still have to design their particular application of the item). However, COTS items that provide a complete solution for a major ROBOT function (e.g. a complete manipulator assembly, pre-built pneumatics circuit, or full mobility system) that require no effort other than just bolting it on to the ROBOT are against the intent of the competition, and will not be permitted.

In addition, another intent of these rules is to have all energy sources and active actuation systems on the ROBOT (e.g. batteries, compressors, motors, servos, cylinders, and their controllers) drawn from a well-defined set of options. This is to ensure that all teams have access to the same actuation resources, and to ensure that the inspectors are able to accurately assess the legality of a given part.

### 8.3.1 Safety & Damage Prevention

<R01> Energy used by *FIRST* Robotics Competition ROBOTS, (i.e., stored at the start of a MATCH), shall come only from the following sources:

- Electrical energy derived from the onboard 12V and 7.2V batteries
- Compressed air stored in the pneumatic system, stored at a maximum pressure of 120 PSI in no more than four Clippard Instruments tanks. Extraneous lengths of pneumatic tubing shall not be used to increase the storage capacity of the air storage system.
- A change in the altitude of the ROBOT center of gravity.
- Storage achieved by deformation of ROBOT parts. Teams must be very careful when incorporating springs or other items to store energy on their ROBOT by means of part or material deformation. A ROBOT may be rejected at inspection if, in the judgment of the inspector, such items are unsafe.

<R02> ROBOT parts shall not be made from hazardous materials, be unsafe, or cause an unsafe condition. Items specifically PROHIBITED from use on the ROBOT include:

- Shields, curtains, or any other devices or materials designed or used to obstruct or limit the vision of any DRIVERS and/or COACHES and/or interfere their ability to safely control their ROBOT
- Speakers, sirens, air horns, or other audio devices that generate sound at a level sufficient to be a distraction or hindrance affecting the outcome of a MATCH
- Any devices or decorations specifically intended to jam or interfere with the remote sensing capabilities (including vision systems, acoustic range finders, sonars, infra-red proximity detectors, etc.) of another robot (i.e. changing ROBOT color to confuse opponent's vision system)
- Lasers of any type
- Flammable gasses
- Materials that off-gas noxious or toxic gasses
- Materials that produce hazardous inhalable particles
- Caustic chemicals
- Hydraulic fluids or hydraulic components

Teams should provide MSD Sheets for any materials they use that might be considered questionable during ROBOT inspection.

<R03> Custom circuits and electronics are expressly PROHIBITED if they:

- Interfere with the operation of other ROBOTS.
- Directly affect any output devices on the ROBOT, such as by providing power directly to a motor, supplying a PWM signal to a speed controller or supplying a control signal to a relay module.

<R04> Protrusions from the ROBOT shall not pose hazards to GAME PIECES, team members or event staff. If, in the judgment of the inspectors or referees, a device on the ROBOT poses a hazard (particularly puncture or impalement hazards), the team will be required to remedy the situation before the ROBOT will be allowed to play. If the ROBOT includes protrusions that form the "leading edge" of the ROBOT as it drives, and are less than one square inch in surface area, it will invite detailed inspection. For example, forklifts, lifting arms, grapplers, etc. may be carefully inspected for these hazards

Note that robot inspectors will be looking for sharp corners and edges that could cause injury, pinch points, entanglement hazards, and impaling projections. Please mitigate all such hazards. This is for the protection of team members as well as game equipment.

- <R05>** Exterior or exposed surfaces on the ROBOT shall not present undue hazards to the team members, event staff or GAME PIECES. Reasonable efforts must be taken to remove, mitigate, or shield any sharp edges, pinch points, entanglement hazards, projectiles, extreme visual/audio emitters, etc. from the exterior of the ROBOT. All points and corners that would be commonly expected to contact a TRACKBALL should have a minimum radius of 0.125 inches to avoid becoming a snag/puncture hazard. All edges that would be commonly expected to contact a TRACKBALL should have a minimum radius of 0.030 inches. All of these potential hazards will be carefully inspected.
- <R06>** ROBOT wheels, tracks, and other parts intended to provide traction on the playing field may be purchased or fabricated (“traction devices” include all parts of the ROBOT that are designed to transmit any propulsive and/or braking forces between the ROBOT and the playing field). In no case will traction devices that damage the carpet or other playing surfaces be permitted. Traction devices shall not have surface features such as metal, sandpaper, hard plastic studs, cleats, or other attachments. Anchors (i.e. devices that are deployed/used to keep one’s ROBOT in one place and prevent it from being moved by another ROBOT) shall not use metal in contact with the carpet or other playing surfaces to “stay put.” Gaining traction by using adhesives or Velcro-like fastener material is not allowed.
- <R07>** MECHANISMS or COMPONENTS on the ROBOT shall not pose obvious risk of entanglement. If, in the judgment of the inspectors, a device on the ROBOT poses an entanglement risk then the team will be required to remedy the situation before the ROBOT will be allowed to play. If the structure of a COMPONENT permits easy penetration by an object less than four square inches in cross section, it will invite detailed inspection. Willful entanglement actions are addressed in Rule <G37>.
- Note: nets, loose rope or wire, voluminous sheets of fabric, etc. may be carefully inspected for these hazards. A 1/8” x 1/8” tight-mesh net (or very loose mesh fabric, depending on your point of view) may be a reasonable material that would not automatically pose an entanglement hazard. However, any flexible material has the potential to become an entanglement hazard if it is not firmly attached to an appropriate structure or left in a loose, voluminous configuration. Therefore, you must use your best judgment to determine if your particular use of the material will pose an entanglement hazard. However, actual performance on the playing field will determine if the potential for entanglement is significant or not.
- <R08>** Teams are required to use STANDARD BUMPERS on their ROBOTS. Bumpers can reduce damage to ROBOTS when they contact another ROBOT or field elements. STANDARD BUMPERS have several advantages, such as being excluded from the calculation of the ROBOT weight and volume limitations specified in Rule <R11>. STANDARD BUMPERS must be constructed as described below.

- **STANDARD BUMPERS** must be designed as shown in figures 8-1 and 8-2. This is the only acceptable design for **STANDARD BUMPERS**.

- **STANDARD BUMPERS** must be removable so that they can be weighed separately from the **ROBOT**.
- **STANDARD BUMPERS** must be attached to the **ROBOT** with a bolt-and-fastener system to form a rigid, robust connection to the **ROBOT** structure (i.e. not attached with Velcro!).

- **STANDARD BUMPERS** must weigh, in total, no more than 15 pounds including any fasteners that attach them to the **ROBOT**.

- **STANDARD BUMPERS** may be segmented. However, each **STANDARD BUMPER** segment must be a minimum of 6 inches in length and must not include sections that weigh more than 3 ounces per inch (i.e. no short bumpers with giant heavy fasteners).

- **STANDARD BUMPERS** must protect a minimum of 2/3 of the perimeter of the **ROBOT** within the **BUMPER ZONE**.

Teams are encouraged to maximize the area of their **ROBOT** protected by bumpers. But up to 1/3 of the perimeter may be unprotected to provide flexibility in design options.

- **STANDARD BUMPERS** must use a stacked pair of 2-1/2 inch "pool noodles" as the bumper material.
- **STANDARD BUMPERS** must use 3/4 inch plywood backing 5 inches tall as the bumper structure to attach the bumper ("pool noodles") to the **ROBOT**.
- **STANDARD BUMPERS** must be covered with a tough smooth cloth (1000 denier Cordura Plus® strongly recommended).

- In the **STARTING CONFIGURATION**, **STANDARD BUMPERS** may extend outside the horizontal dimensions for the **ROBOT** (as specified in Rule <R11>) by up to a maximum of 3-1/2 inches per side. Nothing other than pool noodles and cloth can extend more than 1 inch beyond the **ROBOT** boundaries.

- Hard bumper parts **MUST NOT** extend into the corners.

- **STANDARD BUMPERS** must remain within the **BUMPER ZONE** when the **ROBOT** is resting on the floor in **PLAYING CONFIGURATION**. They must not be articulated or moved outside of the **BUMPER ZONE**.

- For the purposes of the shipping deadlines, **STANDARD BUMPERS** are considered part of the **ROBOT**, and must be shipped in the crate with the **ROBOT**.

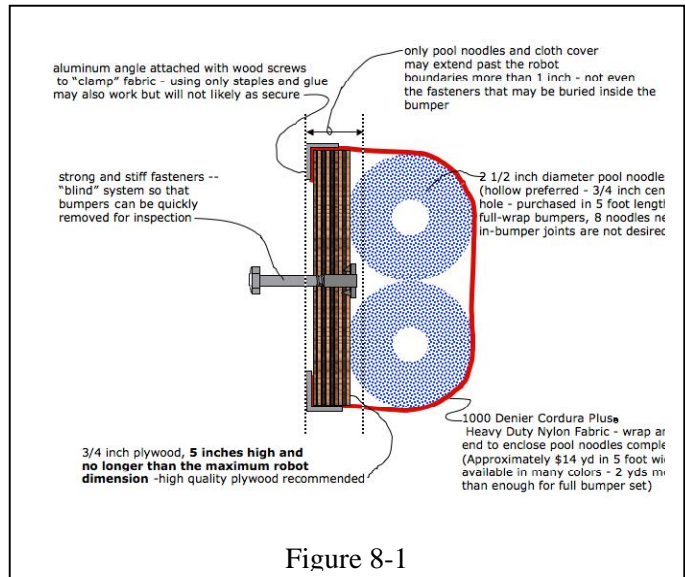

Figure 8-1

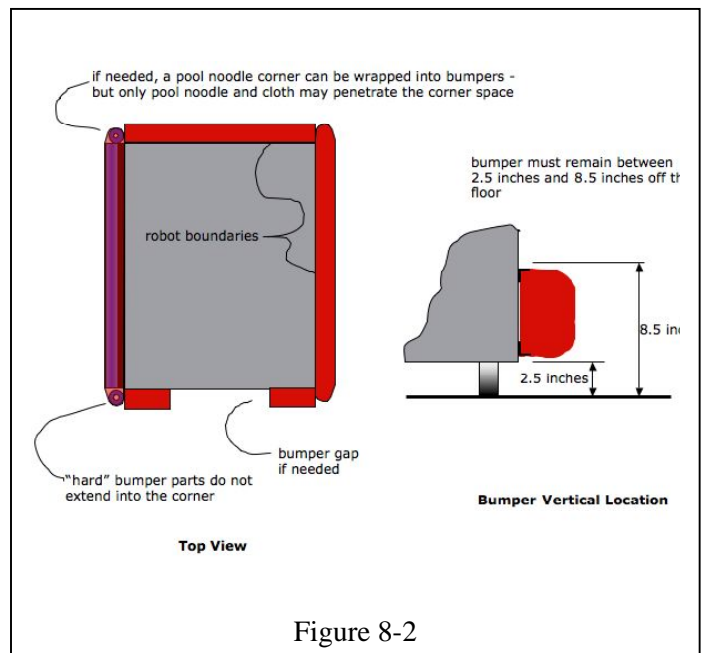

Figure 8-2

Bumper height has been specified so that ROBOTS will make contact bumper-to-bumper and so that the GAME PIECES will be pushed rather than pulled under the ROBOTS. As bumper mounts are being designed, please consider how the ROBOT will be carried (bumpers typically do not make good handles!). Also, note that the use of STANDARD BUMPERS may preclude the use of other technologies in their out-of-the-box configurations. Teams will need to carefully consider the interactions between bumper design options and other elements of their ROBOT design.

### 8.3.2 General Robot Design

<R09> Each registered *FIRST* Robotics Competition team can enter ONE (1) ROBOT into the 2008 *FIRST* Robotics Competition. That ROBOT shall fully comply with all rules specified in the 2008 *FIRST* Robotics Competition manual.

<R10> Robots entered into the 2008 *FIRST* Robotics Competition shall be fabricated and/or assembled from COMPONENTS, MECHANISMS and COTS items that are constructed from:

- Items provided in the *FIRST*-supplied Kit Of Parts (or their exact REPLACEMENT PART)
- Allowed additional parts and materials as defined in the rules, and in quantities consistent with the Budget Constraint rules (found in Section 8.3.3).

<R11> Prior to the beginning of the MATCH, the ROBOT shall be placed in a STARTING CONFIGURATION that fits within the dimensions listed below:

<u>Maximum Width</u>	<u>Maximum Depth</u>	<u>Maximum Height</u>	<u>Maximum Weight</u>
28 inches (71.12cm)	38 inches (96.52cm)	60 inches (152.40cm)	120 pounds (54.43Kg)

Any restraints (elastic bands, springs, etc.) that are used to restrain the ROBOT in its STARTING CONFIGURATION must remain attached to the ROBOT for the duration of the MATCH.

<R12> When determining weight, the basic ROBOT structure and all elements of all additional mechanisms that might be used in different configurations of the ROBOT shall be weighed together. Included in the weight limit are the robot control system, back-up 7.2V battery, decorations, and all other attached parts.

- Example: A team has decided to design their ROBOT such that, before any given MATCH, they may change the configuration of the ROBOT based on perceived strengths or weaknesses of an opponent. The team accomplished this by constructing a basic drive train platform plus two versions of a GAME PIECE manipulator, each manipulator being a quick attach / detach device such that either one or the other (but not both) may be part of the ROBOT at the beginning of a MATCH. Their ROBOT platform weighs 107 lb, version A of the manipulator weighs 6 lb, and version B weighs 8 lb. Although only one version will be on the ROBOT during a MATCH, both manipulators (and all components of the manipulators that would be used during the MATCH) must be on the scale along with the ROBOT platform during weigh in. This would result in a **rejection** of the ROBOT because its total weight comes to 121 lb.

<R13> For the purposes of determining compliance with the weight and volume limitations specified in Rule <R11>, these items are NOT considered part of the ROBOT and are NOT included in the weight and volume assessment of the ROBOT:

- The 12V battery and its associated half of the Anderson cable quick connect/disconnect pair (including no more than 12 inches of cable per leg, the associated cable lugs, connecting bolts, and insulating electrical tape) on board the ROBOT,
- Any STANDARD BUMPER assemblies included on the ROBOT that are in compliance with Rule <R08>, up to a maximum of 15 pounds,
- The FLAG is not considered part of the ROBOT (however, the flag holder specified in Rule <R17> IS considered part of the ROBOT, and is included in the ROBOT weight and volume),
- The OPERATOR CONSOLE.

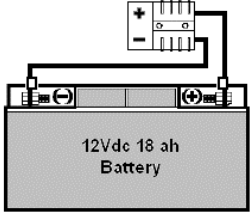
<b>NOTE</b>	
- Weight limit <b>excludes</b> the 12 volt battery and Anderson cable half.	
- Weight and volume limits <b>exclude</b> any STANDARD BUMPERS constructed consistent with Rule <R08>.	
- Weight and height limits <b>exclude</b> the FLAG	

However, for all other purposes the items listed above are considered part of the ROBOT and must comply with all other applicable rules and requirements.

<R14> ROBOTS shall display their school name, and primary sponsor name and/or logo whenever the ROBOT is on the field (including practice sessions). The support provided by the corporate sponsors and mentors on your team is important, and is to be acknowledged with the appropriate display of their names/logos on the exterior of the ROBOT.

<R15> The judges, referees, and announcers must be able to easily identify ROBOTS by team number. Teams shall display their team number in four locations at approximately 90-degree intervals around the perimeter of the ROBOT. **The numerals must be at least 4 inches high, at least in 3/4 inch stroke width and in a contrasting color from its background.** Team Numbers must be clearly visible from a distance of not less than 100 feet.

<R16> Once the MATCH has started, the ROBOT may assume a PLAYING CONFIGURATION that exceeds the size dimensions specified in Rule <R11>. While in the PLAYING CONFIGURATION, the ROBOT may expand up to a maximum horizontal dimension of 80 inches (e.g. all parts of the ROBOT must fit within an imaginary 80-inch-diameter upright cylinder). There are no height limits for a ROBOT in its PLAYING CONFIGURATION at any time after the start of the MATCH other than those specified in Rule <G36> about not exceeding the maximum permitted height while in the opponent's HOME STRETCH.

**<R17>** ROBOTS must use one of the two FLAGS provided at the event queuing location to display their ALLIANCE color (red or blue). The FLAG shall be held in a flag holder mounted on the ROBOT. The FLAG holder is a 12 inch long piece of 1/2" ID Schedule 40 PVC tube. The tube must be a single, contiguous piece, capped with a commercial PVC pipe cap cemented at the bottom end. The tube must not have any "lightening holes" or other modifications other than mounting holes, paint, or other decorative surface finishes. The flag holder must be permanently mounted to the ROBOT such that when the ROBOT is in any PLAYING CONFIGURATION and the FLAG is in the flag holder, the FLAG is approximately vertical and the top of the FLAG is 75 inches above the floor. As the flag pole is approximately 36 inches long, that means the top of the flag holder must be 51 inches above the floor. The region above the flag holder must be kept open and clear of obstructions so that the FLAG can be placed in the holder and displayed during the MATCH and the LAP INDICATOR is visible to the Lap Detectors (see Rule <R18>). The intent of this rule is to insure that the FLAG is as high as possible so that it may be easily seen from any side during the entire MATCH play, while fitting under the OVERPASS as the ROBOT drives around the TRACK.

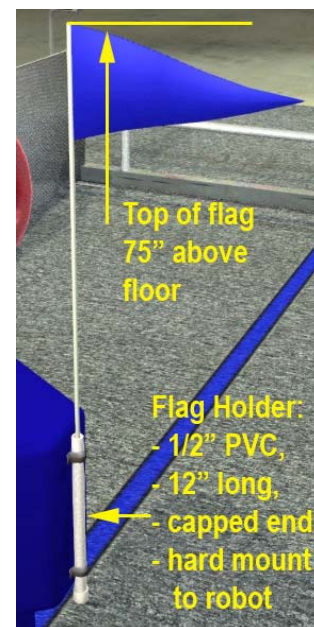

**<R18>** ROBOTS must use the LAP INDICATOR provided by the field personnel during all official tournament MATCHES. The LAP INDICATOR is attached to the stopper on the flag pole. When the FLAG is placed in the flag holder, the stopper will insert into the top of the holder. To accommodate the LAP INDICATOR, the area within a minimum 180-degree horizontal arc around the top of the flag holder must be kept clear of any obstructions within a 2-inch radius. This region must be kept uncovered and visible from above. To ensure that every FINISH LINE CROSSING is properly recorded, the LAP INDICATOR must be visible to the Lap Detectors when the ROBOT passes under the OVERPASS. The LAP INDICATOR is powered via a standard three-wire PWM cable. An easily accessible, powered, male PWM connector must be located within 4 inches of the LAP INDICATOR mounting location. The port may be either a direct connection to an analog or digital port on the Robot Controller, or a remote "pigtail" connection to the Robot Controller port

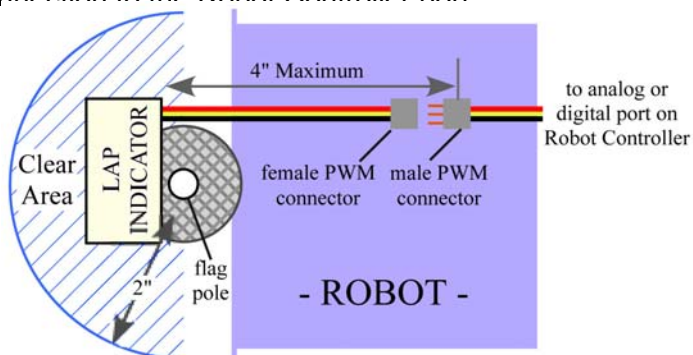

<R19> "Wedge" ROBOTS are not be permitted. ROBOTS shall be designed so that interaction with opposing ROBOTS results in pushing rather than tipping or lifting. Neither offensive nor defensive wedges are allowed. All parts of a ROBOT between 0 and 8.5 inches from the ground (the top of the BUMPER ZONE) that are used to push against or interact with an opposing ROBOT must be within 10 degrees of vertical. Devices deployed outside the ROBOT footprint should be designed to avoid wedging. If a mechanism or an appendage (e.g. a harvester for retrieving GAME PIECES) becomes a wedge that interferes with other ROBOTS, penalties, disabling, or disqualification can occur depending on the severity of the infraction.

<R20> Any non-functional decorations included on the ROBOT must not affect the outcome of the MATCH, and must be in the spirit of "Gracious Professionalism."

### 8.3.3 Budget Constraints

<R21> The costs of all non-2008 Kit parts and materials used in the construction of a ROBOT (as defined in Section 8.1.1) shall be recorded (in US dollars) by the team, and a list of all such items and their costs presented at ROBOT inspection.

<R22> All costs are to be determined as explained in **Section 8.3.3.1 – Cost Determination of Additional Parts**.

<R23> The total cost of all non-Kit Of Parts items shall not exceed \$3,500.00 USD. No individual item shall have a value of over \$400.00. The total cost of COMPONENTS purchased in bulk may exceed \$400.00 USD as long as the cost of an individual COMPONENT does not exceed \$400.00.

<R24> The costs of additional non-spare robot control system components obtained from Innovation First Inc. shall be included in the above \$3,500.00 limit.

<R25> The following items are EXCLUDED from the total cost calculation:

- The cost of any non-functional decorations
- The cost of individual fasteners, adhesives, or lubricants, unless any one component exceeds \$1.00
- The costs of SPARE PARTS. A SPARE PART used as a direct replacement for a failed or defective ROBOT part (either Kit Of Parts item or non-Kit Of Parts item) that has already been included in the cost accounting is covered by the accounting for the original part
- All costs for the construction of the OPERATOR CONSOLE

<R26> Individual COMPONENTS or MECHANISMS retrieved from previous ROBOTS and used on 2008 ROBOTS must have their undepreciated cost included in the 2008 robot cost accounting, and applied to the overall cost limits.

#### 8.3.5.1 Cost Determination of Additional Parts

The "cost" of each non-Kit Of Parts item is calculated based on the following criteria, as applicable:

- The purchase price of a COTS item offered for sale by a VENDOR to any customer.
- The total cost (materials + labor) of an item you pay someone else to make.

- Example: A team orders a custom bracket fabricated by a VENDOR to the team's specification. The VENDOR'S material cost and normally charged labor rate apply.
- The fair market value of an item obtained at a discount or as a donation. Fair market value is that price at which the supplier would normally offer the item to other customers. Also considered to be "fair market value" are the discounted prices offered to all teams by suppliers with established relations with *FIRST*.
  - Example: Special price discounts from MSC Industrial Supply Co. and Terminal Supply Co. are being offered to all *FIRST* teams. The discounted purchase price of items from these sources would be used in the additional parts accounting calculations.
- The cost of raw material obtained by a team + the cost of non-team labor expended to have the material processed further. Labor provided by team members and/or by a recognized team sponsor whose employees are members of the team does not have to be included. Note: it is in the best interests of the teams and *FIRST* to form relationships with as many organizations as possible. Teams are encouraged to be expansive in recruiting and including organizations in their team, as that exposes more people and organizations to *FIRST*. Recognizing supporting companies as sponsors of, and members in, the team is encouraged - even if the involvement of the sponsor is solely through the donation of fabrication labor.
  - Example: A team purchases steel bar stock for \$10.00 and has it machined by a local machine shop. The machine shop is not considered a team sponsor, but donates two hours of expended labor anyway. The team must include the estimated normal cost of the labor as if it were paid to the machine shop, and add it to the \$10.00.
  - Example: A team purchases steel bar stock for \$10.00 and has it machined by a local machine shop that is a recognized sponsor of the team. The machinists are considered members of the team, so their labor costs do not apply. The total applicable cost for the part would be \$10.00.
- The cost of items purchased in bulk or large quantities may be prorated on the basis of the smallest commonly available unit that satisfies the need for the item.
  - Example: A team purchases a 4' x 4' sheet of aluminum, but only uses a piece 10" x 10" on their ROBOT. The team identifies a source that sells aluminum sheet in 1' x 1' pieces. The team may cost their part on the basis of a 1' x 1' piece, even though they cut the piece from a larger bulk purchase. They do not have to account for the entire 4' x 4' bulk purchase item.
- Shipping costs of Non-Kit items are not counted.
- COMPONENTS or MECHANISMS that teams purchase to replace Kit Of Parts items that were not received from *FIRST* are not subject to the cost limitation (i.e., should not be charged against the \$3,500.00 robot limit).
- If the item is part of a modular system that can be assembled in several possible configurations or applications, then each individual module must fit within the price constraints defined in Rule <R23>. If the modules are designed to assemble into a single configuration, and the assembly is functional in only that configuration, then the total cost of the complete assembly including all modules must fit within the price constraints defined in Rule <R23>.

### 8.3.4 Fabrication Schedule

*FIRST* recognizes that it is the responsibility of each team to design and construct their ROBOT within the schedule constraints defined below. As compliance with these rules takes place outside of the competition venues, *FIRST* is not able to directly monitor compliance. One of the fundamental values of *FIRST* is the concept of "gracious professionalism." We are relying upon the honor, integrity, and professional behavior of each team to recognize and abide by the fabrication schedule rules.

Note that the schedule rules apply to both hardware and software development. Hardware and software design processes are thought-intensive activities, and team members are likely to continue to consider and analyze their designs long after the ROBOT is shipped. Teams can not be prevented from thinking about their hardware and software designs, and it is not our intention to do so. However, the timeline permitted for the development of the actual competition version of the ROBOT is severely, and intentionally, restricted. Pondering software issues to be resolved, researching general case solutions, discussing solutions with teammates, collecting raw materials, sketching mechanisms, preparing tools, and outlining high-level descriptions of software algorithms are all reasonable activities outside of the scheduled build periods. But completing detailed dimensioned drawings of parts, and any actual fabrication of any hardware items intended to go on the actual competition ROBOT is prohibited outside of the approved fabrication periods. On the software side, developing detailed pseudo-code, writing actual lines of code, verification of syntax, final debugging, etc would all be considered development of the final software implementation, and must be completed during the approved fabrication periods.

**<R27>** Prior to the Kick-off: Before the formal start of the Robot Build Season, teams are encouraged to think as much as they please about their ROBOTS. They may develop prototypes, create proof-of-concept models, and conduct design exercises. Teams may gather all the raw stock materials and COTS COMPONENTS they want. But absolutely no fabrication or assembly of any elements intended for the final ROBOT is permitted prior to the Kick-off presentation

**<R28>** During the Build Season: During the period between the Kick-off and ROBOT shipment deadline, teams are to design and fabricate all the COMPONENTS and MECHANISMS required to complete their ROBOT. They are encouraged to use all the materials, sources and resources available to them that are in compliance with the rules of the 2008 *FIRST* Robotics Competition. When the ROBOT shipment deadline arrives, all work on the ROBOT must cease and the ROBOT must be placed in a “hands-off” condition. The entire ROBOT (including all FABRICATED ITEMS intended for use during the competition in alternative configurations of the ROBOT) and OPERATOR CONSOLE must be crated and out of team hands by the shipment deadline specified in Section 4.5.1.1.

**<R29>** During the “FIX-IT WINDOWS” following the shipment of the ROBOT: During this period, all teams may utilize up to 10 hours of FIX-IT-WINDOWS to manufacture SPARE and REPLACEMENT PARTS and develop software for their ROBOT at their home facility. Fabrication of UPGRADE PARTS is not permitted during this period. The timing of these “FIX-IT WINDOWS” is at the discretion of the team. However, the total time utilized as FIX-IT WINDOWS during this period must not exceed 10 hours, and all work must be completed by 5:00pm on the Saturday following the ROBOT shipment deadline. Teams may manufacture all the SPARE and REPLACEMENT parts they want, but the amount of parts they can bring to a competition event is limited (as specified in Rule <R41>).

The intent of the FIX-IT WINDOWS is to permit teams to prepare parts that have, or are likely to, become damaged during the course of a competition event, so they may continue to participate. Teams do not have direct access to their ROBOT during these periods, and must rely on information they generated and documented during the design and build process to determine the fit and function of any parts developed during FIX-IT WINDOWS. This is true for both hardware and software.

<R30> Prior to the competitions: After the close of the “FIX-IT WINDOWS” and prior to the competition, the team must put down their tools, cease fabrication of ROBOT parts, and cease all development of ROBOT software. Take this opportunity to rest, recover from the build season, and relax. Teams may scout other teams, gather and exchange information, develop game-playing strategies, collect raw materials, prepare tool kits, plan how to make repairs, etc. in preparation for the upcoming competitions. But no construction or fabrication of any hardware, or development of any software, is allowed.

<R31> At the competitions: Teams are allowed to repair, modify or upgrade their competition ROBOT while participating in a competition event. To support this, teams may bring SPARE, REPLACEMENT and UPGRADE PARTS and COTS items to the competitions (within the limits specified in Rules <R40> and <R41>). Work can only be done on-site in the Pits or at any facility made available to all teams at the event (e.g., in a team’s repair trailer or a local team’s shop offered to all teams to use). Fabrication may be done when the Pit area is open for normal operations during the period starting with the opening of the Pit area on Thursday and ending at 4:00PM on Saturday. All work must be completed when the Pit area closes each evening. Parts shall not be removed from the competition site and retained overnight after the Pit area closes.

<R32> During the “FIX-IT WINDOW” following each Regional Competition weekend: During this period, all teams (not just those teams attending a Regional Competition) may utilize up to 10 hours of FIX-IT-WINDOWS to manufacture SPARE, REPLACEMENT and UPGRADE PARTS and develop software for their ROBOT at their home facility (not at the competition site). The timing of these “FIX-IT WINDOWS” is at the discretion of the team. However, the total time utilized as FIX-IT WINDOWS during this period must not exceed 10 hours, and all work must be completed between the opening of the Competition (at 8:30 am on the Thursday of the Competition weekend) and 8:30 am on the Thursday following the Competition weekend. At the conclusion of a regional competition event, teams may take a limited amount of broken or malfunctioning COMPONENTS or MECHANISMS back to their home facility to make SPARE or REPLACEMENT PARTS. Teams may manufacture and/or repair all the parts they want, but the amount of parts they can bring to the competition event is limited (as specified in Rule <R41>).

The purpose of this rule is to allow teams to make critical repairs to existing parts to enable them to compete in following events. The intent of this rule is not to have teams take their entire ROBOT back home and make large-scale revisions or upgrades to the ROBOT.

### 8.3.5 Material Utilization

<R33> The use of non-Kit Of Parts items or materials shall not violate any other robot design or fabrication rule.

<R34> Teams may replace lost or damaged Kit Of Parts COMPONENTS only with identical COMPONENTS of the same material, dimensions, treatment, and/or part number.

<R35> COTS ITEMS that are generally available may be used on the ROBOT. The parts shall be generally available from suppliers such that any other *FIRST* team, if it so desires, may also obtain them at the same price. A specific device **fabricated by a team** from non-2008 Kit Of Parts materials for their use does not have to be available to others; however, the materials it is made from must be available to other teams.

- <R36>** COTS ITEMS from ROBOTS entered in previous FIRST competitions or COTS MECHANISMS that are no longer commercially available may be used under the following conditions:
- The item must be unmodified, and still in its original condition as delivered from the VENDOR
  - The item must not be a part custom made for the *FIRST* competition and provided in the Kit Of Parts for a previous *FIRST* Robotics Competition (e.g. 2006 FRC transmissions, custom-made motor couplers, custom sensor strips, 2006 IFI CMUcam II modules, etc. are not permitted)
  - The item must satisfy ALL of the rules associated with materials/parts use for the 2008 *FIRST* Robotics Competition)
- <R37>** FABRICATED ITEMS from ROBOTS entered in previous *FIRST* competitions shall not be used on ROBOTS in the 2008 competition.
- <R38>** Adhesive backed tapes shall not be used as a structural fastener, or to connect two or more parts together. Adhesive backed tapes may only be used as follows:
- Textured or coated tapes may be used to provide an alternate surface finish or treatment to a portion of the ROBOT.
  - Velcro tape, any hook and loop tape or double-sided sticky foam may be used for attaching components to the ROBOT.
  - Reflective tape may be used with optical sensors in small amounts.
  - Adhesive backed tape and labels may be used for labeling purposes on wires, cables, pneumatic lines, etc.
  - Electrical tape may be used as an electrical insulator.
- <R39>** Lubricants may be used only to reduce friction within the ROBOT. Lubricants shall not be allowed to contaminate the playing field or other ROBOTS.
- <R40>** Teams may acquire and bring an unlimited amount of COTS items to the competitions to be used to repair and/or upgrade their ROBOT at the competition site.
- <R41>** Teams may bring a maximum of 25 pounds of custom FABRICATED ITEMS (SPARE PARTS, REPLACEMENT PARTS, and/or UPGRADE PARTS) to each competition event to be used to repair and/or upgrade their ROBOT at the competition site. All other FABRICATED ITEMS to be used on the ROBOT during the competition shall arrive at the competition venue packed in the shipping crate with the ROBOT.
- <R42>** Teams participating in the 2008 *FIRST* Robotics Competition that are located outside North America may not be able to acquire the exact part (as identified by specific part numbers) or materials of the specified dimensions as defined in these rules. In such situations, international teams must submit a request for approval of nearest-equivalent parts (e.g. nearest metric equivalent, etc.) to *FIRST* Headquarters. *FIRST* will determine suitability of the part. If approved, a confirming e-mail will be sent to the team. The team must bring a copy of the e-mail to any competition event to verify that the use of an alternate part has been approved.

### 8.3.6 Power Distribution

- <R43> The only legal main source of electrical energy on the ROBOT during the competition is the 12VDC non-spillable lead acid battery provided in the 2008 Kit Of Parts. That 12V battery is the MK Battery, ES17-12. Additional batteries may be purchased through a local MK Battery supplier. Teams may use other equivalent 12V batteries during development, testing and practice MATCHES. However, during the qualifier and elimination MATCHES, only the MK Battery, ES17-12 can be used (**this means NO pre-2007 batteries can be used during qualification and elimination MATCHES at any official 2008 FIRST competition**).
- <R44> Additional electrical system items specifically permitted on 2008 FRC ROBOTS include:
- Additional Innovation First, Inc. Victor 884 speed controllers
  - Additional Innovation First, Inc. Spike relay modules
  - One additional 4-slot Maxi-block circuit breaker panel may be utilized on their 2008 ROBOT in addition to, or in replacement of, the circuit breaker panels provided in the Kit Of Parts
- <R45> Items specifically PROHIBITED from use on the ROBOT include:
- Primary 12v batteries different from those provided in the Kit Of Parts (i.e. manufacturer and part number must be the same as those provided in the Kit Of Parts)
  - More than one primary battery, or more than one back-up battery
  - Circuit breakers different from those provided in the Kit Of Parts. Note: the Snap Action brand circuit breakers provided have unique “trip” characteristics. No substitute brands are permitted.
  - Fuse panels different from those provided in the Kit Of Parts
  - Motor speed controllers other than Innovation First, Inc. Victor 884 speed controllers
  - Relay modules other than Innovation First, Inc. Spike relays
- <R46> Electrical devices shall be wired using commercially available copper wire for all electrical connections. Aluminum (or other non-copper material) wire is prohibited.
- <R47> All main and branch circuits shall be wired with appropriately sized wire:
- **12 AWG or larger** diameter wire must be used for all circuits protected by a 40A circuit breaker.
  - **14 AWG or larger** diameter wire must be used for all circuits protected by a 30A circuit breaker.
  - **18 AWG or larger** diameter wire must be used for all circuits protected by a 20A circuit breaker.
  - **24 AWG or larger** diameter wire must be used for providing power to pneumatic valves.
- <R48> The ES17-12 shall only be charged between MATCHES by a 6-ampere rated automatic battery charger. When recharging the Kit Of Parts batteries, either the charger provided by FIRST or an automatic charger with an equivalent charging current rating may be used.

- <R49> The 7.2v backup battery may be charged on or off the ROBOT. When off the ROBOT, the battery is to be charged with a 7.2V backup battery charger. When mounted on the ROBOT, the backup battery may be charged from the 12VDC primary battery by using the custom charging circuit available from Innovation First Inc. or any similar charging circuit (note: IFI will provide the design for this circuit on the IFI website, however teams must obtain the parts for this circuit and assemble it themselves). The use of this circuit is strongly encouraged.
- <R50> The 12V battery, the main 120-amp circuit breaker, the power distribution block, and circuit breaker distribution panels shall be connected as shown in the **2008 Power Distribution Diagram**. In particular:
- The battery must be connected to the ROBOT power system through the use of the Anderson Power Products (APP) connector.
  - The APP connector must be attached to the battery with either the copper lugs provided in the FCI Burndy Bag or appropriate crimp-on lug connectors.
  - The battery terminals and the connecting lugs must be insulated with shrink tubing and/or electrical tape.
  - The main 120-amp circuit breaker must be directly connected to the hot (+) leg of the ROBOT-side APP connector. Only one 120 amp main circuit breaker is allowed. This breaker must not be bypassed.
  - The power distribution block must be directly connected to the APP connector and main 120-amp circuit breaker. No other loads may be connected to the main 120-amp circuit breaker.
  - All circuit breaker distribution panels must be connected directly to the power distribution block. No intermediate connections are permitted.
  - Additional lengths of #6 red and #6 black wire may be used to reach the panels as needed to make the above connections.
  - Circuit breakers must be accessible for inspection at each *FIRST* Robotics Competition event.
- <R51> All wiring and electrical devices shall be electrically isolated from the ROBOT frame; the ROBOT frame must not be used to carry electrical current (this isolated ground arrangement is necessary due to polarity reversals that occur under certain operating conditions such as during motor direction reversals).
- <R52> All 12v electric power used on the ROBOT shall be obtained from the load terminals of the circuit breaker distribution panels.
- <R53> Custom circuits shall NOT directly alter the power pathways between the battery, fuse blocks, speed controllers, relays, motors, or other elements of the robot control system (including the power pathways to other sensors or circuits). Custom high impedance voltage monitoring or low impedance current monitoring circuitry connected to the ROBOT'S electrical system is acceptable, because the effect on the ROBOT outputs should be inconsequential.
- <R54> All wires distributing power with a constant polarity (i.e., except for relay module, speed controller, or sensor outputs) shall be color-coded as follows:
- Use red, white, or brown wire for +12 Vdc and +5 Vdc connections.
  - Use black or blue wire for common (-) connections.

**<R55>** All active circuit breaker / power distribution panel branch circuits shall be protected from overload with an appropriate value auto resetting Snap Action circuit breaker from the Kit Of Parts.

- The Robot Controller power feed must be protected with a 20A circuit breaker. No other electrical load can be connected to this breaker.
- If the compressor is used, the air compressor Spike relay power feed must be protected with a 20A fuse or 20A circuit breaker. No other electrical load can be connected to this breaker.
- Power feeds to custom circuits and additional electronics must be protected with a 20A circuit breaker.

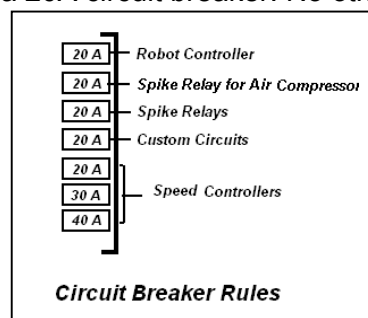

- Speed controllers must be protected by 20A, 30A, or 40A circuit breakers.
- Relay modules must be protected with a 20A circuit breaker.

In addition to the required branch power circuit breakers, smaller value fuses or breakers may be incorporated into custom circuits for additional protection.

**<R56>** Each power regulating device (Victor speed controller or Spike relay) shall control one and only one electrical load (motor, actuator or compressor). Multiple low-load devices (e.g. pneumatic valves) may be connected to relay modules (but only one motor may be connected to each relay module).

**<R57>** Decorations may draw power from the 12v electrical system as long as they are powered via a dedicated 20A circuit breaker and do not affect the operation of other control system components.

### 8.3.7 Motors & Actuators

**<R58>** Motors, pumps, and, Robot Controllers from previous robots shall not be used in addition to those provided in the 2008 Kit Of Parts. They may be used as direct one-to-one SPARE PARTS for those provided if the provided part fails or is damaged. They can only be used if they are identical to the part being replaced.

- Note that the Fisher-Price motor found in the 2008 Kit Of Parts (Part number 00968-9015) is different from the Fisher-Price motors used in most previous FIRST competitions. Only the Fisher-Price 00968-9015 motor may be used as a SPARE PART for the Fisher-Price motors provided in the 2008 Kit Of Parts.

**<R59>** Additional motors specifically permitted on 2008 FRC ROBOTS include:

- All motors, actuators, and servos provided in the 2008 Kit Of Parts,
- HITEC HS-322HD servos,
- FIRST Tech Challenge (FTC) servos (Innovation First part number 276-2162),
- FIRST Tech Challenge (FTC) motors (Innovation First part number 276-2163),
- One or two additional 2-1/2" CIM motors (part #FR801-001 and/or M4-R0062-12 in addition to those provided in the Kit Of Parts. This means that up to four, and no more, 2-1/2" CIM motors can be used on the ROBOT.

<R60> Items specifically PROHIBITED from use on the ROBOT include:

- Electric motors and/or servos different from, or in addition to, those in the Kit Of Parts, with the exception of those specifically permitted by Rule <R59>.
- Electric solenoid actuators (note: electric solenoid actuators are NOT the same as pneumatic solenoid valves – the latter are permitted, the former are not).

<R61> So that the maximum power level of every ROBOT is the same, motors used on the ROBOT shall not be modified in any way, except as follows:

- The mounting brackets and/or output shaft/interface of the motors may be modified to facilitate the physical connection of the motor to the ROBOT and actuated part.
- The gearboxes for the Fisher-Price and Globe motors are not considered “integral” and may be separated from the motors.
- The electrical input leads on the motors may be trimmed to length as necessary.

The intent is to allow teams to modify mounting tabs and the like, not to gain a weight reduction by potentially compromising the structural integrity of any motor. The integral mechanical and electrical system of the motor is not to be modified. Note that FIRST will not provide replacements for modified parts.

<R62> All electrical loads (motors, actuators, compressors) must be controlled by relay or PWM output signals sent by the Robot Controller to an appropriate power regulating device

- Each CIM motor and Fisher-Price motors must be connected to one Victor speed controller. They must not be connected to relay modules.
- Servos must be directly connected to the PWM ports on the Robot Controller. They must not be connected to speed controllers or relay modules.
- FTC motors must be directly connected to the Robot Controller. They must not be connected to speed controllers or relay modules.
- If used, the compressor must be connected to one Spike relay module.
- Each other electrical load (motors or actuators) must be connected to one Victor speed controller or one Spike relay module.

### 8.3.8 Control, Command & Signals System

<R63> ROBOTS must be controlled via the wireless, programmable Innovation First 2008-Robot Control System provided in the 2008 Kit Of Parts.

<R64> The radio modems provided in the 2008 Kit Of Parts are the only permitted method for communicating to and from the ROBOT during the MATCH (except as noted below in Rule <R65> and Rule <R84>). Radio modems from previous *FIRST* competitions must not be used. The radio modem must be connected directly to the Robot Controller using one of the DB-9 cables provided in the 2008 Kit Of Parts. No other form of wireless communications shall be used to communicate to, from or within the ROBOT (e.g. no Bluetooth devices are permitted on the ROBOT).

<R65> SIGNALING DEVICES shall be designed to communicate signals from the ROBOCOACH to the ROBOT. SIGNALING DEVICES are excluded from Rule <R64>. SIGNALING DEVICES shall:

- use either passive (no emission of any electromagnetic radiation) or active (emits some restricted form of electromagnetic radiation) means of communication

- be hand held and completely supported by the ROBOCOACH when operated
- does not attach to anything or anyone other than the ROBOCOACH
- exclusively receives input from, and is operated by, the ROBOCOACH
- not receive any input or feedback directly from the ROBOT (the ROBOCOACH may receive feedback from the ROBOT and use it to control the SIGNALING DEVICE)
- be no larger than 3 feet tall by 3 feet wide by 1 foot deep (to fit within the confined volume of the ROBOCOACH STATION)
- remain entirely within the ROBOCOACH STATION
- use a maximum of four different inputs from the ROBOCOACH (e.g. use four different buttons) during any single MATCH
- communicate no more than four messages, states or conditions to the ROBOT (please refer to Rule <R69> and Rule <G01> for additional information) during any single MATCH.

Active SIGNALING DEVICES shall:

- use visible light, infrared communications, or sound as the transmission method – no other form of electro-magnetic radiation is permitted
  - a. All radio frequency communications (as defined by the United States Federal Communications Commission) are explicitly prohibited.
  - b. All laser-based communications by any device classified by the U.S. Department of Labor Occupational Safety and Health Administration (OSHA) as a laser are explicitly prohibited.
  - c. All communications must satisfy Rule <S01>.
- not be used to interfere with any other ROBOT
- be able to switch between no more than four states or conditions (i.e. send no more than four messages)
- be operated through only a single input at any given time (e.g. may not be operated by depressing two buttons at one time)
- not use changes in the signal states to encode or transmit larger messages (e.g. Morse code)

**<R66>** ROBOTS shall use the diagnostic LED flasher provided in the Kit Of Parts. Field personnel will use the LED flasher during the MATCHES for diagnostic purposes. It must be mounted on the ROBOT such that it is easily visible while standing three feet in front of the ROBOT in the STARTING CONFIGURATION. Instructions for connecting the LED flasher are provided on the *FIRST* website at [www.usfirst.org/frc/2008/manual](http://www.usfirst.org/frc/2008/manual). The Robot Controller directly powers and controls the LED flasher. The team has no control over the LED flasher and no programming is required.

**<R67>** The control system is provided to allow wireless control of the ROBOTS. The Operator Interface, Robot Controller, speed controllers, relay modules, radio modems, batteries, battery charger, AC adapter, and 9-pin cables shall not be tampered with, modified, or adjusted in any way (tampering includes drilling, cutting, machining, gluing, rewiring, etc.), with the following exceptions:

- Dip switches on the Operator Interface may be set as appropriate.
- User programmable code in the Robot Controller may be customized.
- Speed controllers may be calibrated as described in owner's manuals.
- The fuse on the Spike relay for the air compressor may be replaced with a 20 Amp Snap-Action circuit breaker.

- <R68> Additional electronic components for use on the ROBOT must be either COTS items, or assembled from COTS items. Additional electronic components include any object that intentionally conducts electricity, other than Innovation First Inc. relays and speed controllers, wires, connectors, solder, and fabricated printed circuit boards.
- <R69> Reaction of the ROBOT to communications received from the SIGNALING DEVICE must meet all of the following criteria:
- For a single MATCH, the ROBOT shall be limited to react to a maximum of four distinct commands - either through hardware or software limitations, or a combination of the two.
  - The ROBOT shall not dynamically change the recognized command set during a MATCH.
  - The ROBOT may only seek out and react to permitted SIGNALING DEVICES belonging to the assigned ALLIANCE (as defined in Rule <R65>). Intentionally reacting to other SIGNALING DEVICES is prohibited.
- <R70> **24 AWG** or larger diameter wire must be used for:
- connecting sensors, switches, potentiometers, accelerometers, and other detection devices
  - connecting a vision system to Robot Controller inputs,
  - extending the PWM cables,
  - connecting small muffin fans,
  - wiring LEDs
- <R71> Ribbon cable smaller than 24 AWG may be used to connect signal lines to the 9-pin ports on the Robot Controller.
- <R72> The Robot Controller must be positioned within the ROBOT so that its indicator lights can be seen during inspection and when standing three feet in front of the ROBOT while the ROBOT is in the STARTING CONFIGURATION at the beginning of a MATCH. This will greatly facilitate analysis in case of problems.
- <R73> The 7.2V Robot Control backup battery shall be connected to the Robot Controller as described in the Robot Controller manual. The 7.2v “backup” battery is considered an integral part of the Robot Controller, and shall not be used for any other purpose. The 7.2v battery should be charged to at least 7.0v before entering a MATCH. As a replacement for the *FIRST*-supplied battery, any other commercially available 7.2V NiCad battery pack may be used.
- <R74> A remote reset and remote programming switch may be wired to the Robot Controller RESET/PROG header. Any switch may be used. See the ***Robot Controller Reference Guide*** for wiring information.
- <R75> Digital outputs of the Robot Controller may be connected directly to brake/coast headers on the speed controllers to permit programmable control of this speed controller function. The brake/coast header on the speed controller may NOT be connected to any other circuit or input.

- <R76> 12Vdc power, relay module outputs, speed controller outputs, or PWM outputs must not be connected to the analog or digital I/O on the Robot Controller.
- <R77> Every speed controller, relay module, servo and FTC motor shall be connected via PWM cable to the Robot Controller, and be controlled by signals provided by the Robot Controller. They shall not be controlled by signals from any other source.
- <R78> Unaltered software modules developed by the team during prior competitions shall not be directly re-used. Just as designs for hardware COMPONENTS may be reused from one year to the next, software algorithms and designs may be reused. However, the specific lines of code must be customized for each ROBOT each year.
- <R79> For the purposes of the *FIRST* Robotics Competition, generally available software modules obtained from open sources (e.g. professional publications, commonly used FRC community-accessible web resources, industry source code repositories, etc.) that are not specifically affiliated with individual FRC teams shall be considered COTS items, and may be used.
- <R80> Teams are responsible for any software bugs introduced into the Robot Controller's control program when using a custom program, or for any unwanted or unanticipated ROBOT behavior when using additional electronics.
- <R81> The use of additional electronics (beyond those provided in the Kit Of Parts) is permitted to allow teams to construct custom circuits for their ROBOTS. Custom circuits may be used to indirectly affect the robot outputs by providing enhanced sensor feedback to the Robot Controller to allow it to more effectively decide how to control the ROBOT.
- <R82> Inputs to custom circuits can be connected to the following sources:
- Branch circuit breaker outputs
  - Speed controller or relay module outputs
  - PWM, relay or digital outputs on Robot Controller
  - Switches, potentiometers, accelerometers, sensors, and other additional permitted electronics.
- <R83> All outputs from sensors, custom circuits and additional electronics shall connect to other custom circuits or the Robot Controller. If connected to the Robot Controller, they must connect through the analog inputs, digital I/O, TTL Serial Port, or Program Port only. Custom circuits must not connect to the Robot Controller through any other ports. Custom circuit outputs shall not be connected to speed controllers, relay modules, pneumatic valves, servos, motors, or actuators.
- <R84> A signal filter may be wired across motor leads or PWM leads. For the purposes of inspection and rules compliance, such filters will not be considered custom circuits, and will not be considered a violation of Rule <R53> or Rule <R83>. Acceptable signal filters are:
- A one microfarad (1  $\mu$ F) non-polarized capacitor may be applied across the power leads of any motor on your ROBOT (as close to the actual motor leads as reasonably possible)
  - A ten kilo-ohm (10 k $\Omega$ ) or larger resistor may be used as a shunt resistor in-line with the PWM control signal feeding a servo

<R85> Any decorations that involve broadcasting a signal to/from the ROBOT, such as remote cameras, must be cleared with *FIRST* Engineering prior to the event and tested for communications interference at the venue. Such devices, if reviewed and approved, are excluded from Rule <R64>. Note that 900 MHz camera systems will not be approved, and are not permitted at any time.

### 8.3.9 Pneumatic System

<R86> To satisfy multiple constraints associated with safety, consistency, robot inspection, and constructive innovation, no pneumatic parts other than those explicitly permitted by the Pneumatic System Rules may be used on the ROBOT.

<R87> Additional pneumatic system items specifically permitted on 2008 FRC ROBOTS include:

- One or two additional Clippard air storage tanks (Clippard Part Number AVT-32-16), equivalent to those provided in the kit. This means that up to four, and no more, Clippard air storage tanks can be used on the ROBOT.
- Pneumatic pressure relief valves identical to those provided in the Kit Of Parts (Parker Part Number PV609-2).
- Prior year *FIRST* Kit Of Parts solenoid valves, and pneumatic tubing may be used in addition to those provided in the 2008 Kit Of Parts. Their costs must be accounted for as explained in **Section 8.3.3 Budget Constraints**.
- Additional 1/8 inch inside diameter pneumatic tubing functionally equivalent to that provided in the Kit Of Parts, with the pressure rating clearly factory-printed on the exterior of the tubing (note: alternate tubing colors are acceptable).
- Pressure transducers may be used as long as they are rated to at least 125psi.
- For the purposes of the *FIRST* competition, a device that creates a vacuum is not considered to be a pneumatic device and is allowed. This includes, but is not limited to, venturi-type vacuum generators and off-the-shelf vacuum devices (as long as they are powered by provided or permitted motors).
- For the purposes of the *FIRST* competition, closed-loop pneumatic (gas) shocks are not considered pneumatic devices, and are permitted additions to the ROBOT.

<R88> There is no limit to the number of solenoid valves, pressure regulators, pressure gauges, and connecting fittings that may be used on the ROBOT. All such devices must be “off the shelf” pneumatic devices rated by their manufacturers for pressure of at least 125psi.

<R89> In addition to the pneumatic cylinders provided in the Kit Of Parts and the “free” pneumatic cylinders available for order through the Free Pneumatic Components Order Form, additional air cylinders or rotary actuators may be used. All cylinders, regardless of source, must be identical to those listed on the Free Pneumatic Components Order Form (e.g. same part numbers). Any additional air cylinders must source from Bimba or Parker Hannifin, or be recovered from prior year *FIRST* Kit Of Parts.

<R90> Items specifically PROHIBITED from use on the ROBOT include:

- Any air compressor other than, or in addition to, the one provided in the Kit Of Parts.
- Pneumatic cylinders and actuators different from those in the Kit or found on the Free Pneumatic Components Order form, with the exception of those specifically permitted by Rule <R89>.

- <R91> If pneumatic components are used on the ROBOT, the pneumatic system on the ROBOT must contain as a minimum the following components, connected in accordance with this section.
- Pressure gauges to display the “working” and “stored” air pressure.
  - An easily visible and accessible pressure vent valve to manually relieve the stored pressure.
  - A pressure relief valve, calibrated and set to release at 125psi.
  - A pressure switch, calibrated and connected to the Robot Controller.
- <R92> Pneumatic components supplied in the Kit Of Parts (compressor, regulators, pressure switches, cylinders, valves, fittings, tubing, etc.) can not be modified except as follows:
- The tubing may be cut.
  - The wiring for the valves and pressure switch may be modified as necessary to interface with the control system.
  - Mounting and connecting pneumatics components using the pre-existing threads, mounting brackets, etc., is not considered a modification of the components. Removing the pin from the rear of an air cylinder is allowed as long as the cylinder itself is not modified.
- Do not, for example, file, machine, or abrasively remove any part of an air cylinder. Consider pneumatic components sacred. They must remain in “out of the shipping box” condition.
- <R93> Compressed air for the pneumatic system on the ROBOT must be provided by the Thomas Industries compressor provided in the 2008 Kit Of Parts. Compressed air shall not come from any other source.
- <R94> The compressor may be mounted on the ROBOT, or it may be left off the ROBOT and used to pre-charge compressed air in the storage tanks prior to bringing the ROBOT onto the playing field. Off-board compressors must be controlled and powered by the ROBOT. The only difference between an on- and off-board compressor is that the off-board compressor is physically removed from the ROBOT. Note: the intent of this rule is to permit teams to take advantage of the weight savings associated with keeping the compressor off-board. But using the compressor off-board of the ROBOT does NOT permit non-compliance with any other applicable rules.
- <R95> **Teams are not allowed to adjust the 125-psi relief valve.** The valve has been calibrated prior to shipping. The relief valve must be attached to the compressor. If the compressor is not used on the ROBOT, then an additional relief valve must be obtained and included in the primary pneumatic circuit on the ROBOT (see Rule <R91>).
- <R96> The Nason pressure switch must be connected to the high-pressure side of the pneumatic circuit (i.e. prior to the pressure regulator) to sense the “stored” pressure of the circuit. The two wires from the pressure switch must be connected directly to a digital input and ground terminal on the Robot Controller, and the controller must be programmed to sense the state of the switch and operate the relay module that powers the compressor.
- <R97> The Parker pressure vent valve must be connected to the pneumatic circuit such that, when manually operated, it will vent to the atmosphere to relieve all stored pressure. The valve must be placed on the ROBOT so that it is visible and easily accessible.

<R98> “Working” air pressure on the ROBOT must be no greater than 60psi. All working air must be provided through the Norgen adjustable pressure regulator, and all other pneumatic components must be downstream from this regulator. A pressure gauge must be placed adjacent to the pressure regulator and display the downstream pressure.

### 8.3.10 Operator Interface

<R99> Innovation First, Inc. Operator Interface units from pre-2008 competitions shall not be used.

<R100> The team number settings on the Operator Interface must be set to the team number assigned to the team by *FIRST*. Every time changes are made to the team number setting on the Operator Interface, the Robot Controller must be tethered to the Operator Interface to transfer the team number setting to the Robot Controller.

<R101> The OPERATOR CONSOLE designed by the team must fit on the 60” wide by 12” deep shelf in the Alliance Station (excluding any items that are held or worn by the DRIVERS during the MATCH).

<R102> Teams are permitted to connect a portable computing device (Laptop computer, PDAs, etc.) to the RS-232 output of the dashboard port of the Operator Interface for the purpose of displaying feedback from the ROBOT while participating in competition MATCHES. Please note that ***AC power will not be available at the playing field so these devices will have to run on internal batteries.***

<R103> The Operator Interface must be positioned within the OPERATOR CONSOLE so that the indicator lights can be clearly seen during inspection and during operation in a MATCH. The ports on the Operator Interface must be easily and quickly accessible. This will greatly facilitate analysis by field personnel in case of problems during the competition.

<R104> Nothing can be connected to the tether port of the Operator Interface during a MATCH.

<R105> All equipment connected to the joystick ports of the Operator Interface must be powered solely through the power available through the port. External power sources of any type are not permitted on any equipment connected to the joystick ports. Portable computing devices *must not* be connected to joystick input ports on the Operator Interface. Power-passive devices (e.g. joysticks that draw their power solely through the Operator Interface joystick port) are permitted.

<R106> Devices connected to the joystick ports of the Operator Interface via a FIRST-approved USB adapter (the only approved USB adapter is IFI Part Number USB-CHICKLET) are excluded from Rule <R105>. If used, this USB adapter must be powered with a 7.2V battery functionally identical to the back-up battery. Power from the competition port or any other source shall not be used to power the USB adapter. The USB adapter must be positioned within the OPERATOR CONSOLE so that the indicator lights may be seen during inspection and operation in a MATCH.

<R107> During competition MATCHES, the competition cable at the Alliance Station must connect directly to the competition port on the Operator Interface. No intermediate connectors, cables, or “pigtailed” are permitted.

### 8.3.11 Robot Inspection

- <R108> The ROBOT will be inspected for compliance with the maximum permissible dimensions while in its STARTING CONFIGURATION. The ROBOT must fit within a *FIRST* Sizing Device that has inside surface dimensions as specified in Rule <R11>. Other than resting on the floor of the Sizing Device, no part of the ROBOT can break the plane of the sides or top of the Sizing Device during size inspection. The ROBOT must be self-supporting while in the Sizing Device.
- <R109> All ROBOTS shall pass inspection for compliance with the rules herein before being allowed to compete in qualification MATCHES. At the time of inspection, teams must present a list of all non-Kit Of Part items and costs used in the construction of their ROBOT to the inspector.
- <R110> At inspection, noncompliance with any robot construction rule may result in disqualification of the ROBOT from the *FIRST* competition event. The team must bring the ROBOT into compliance before they will be allowed to compete in qualification MATCHES.
- <R111> Decorations must be on the ROBOT at the time of final inspection, and must not cause the ROBOT weight or size to exceed the limits specified in Rule <R11>.
- <R112> ROBOTS will normally be allowed to participate in scheduled practice MATCHES prior to passing inspection. However, the lead inspector and/or head referee may determine at any time that the ROBOT is unsafe, and may prohibit further participation in practice MATCHES until the condition is corrected and the ROBOT passes inspection.
- <R113> If a team makes a modification to the ROBOT after it has passed inspection, that team must have the ROBOT re-inspected. If an observation is made that another team's ROBOT may be in violation of the robot rules, please approach *FIRST* officials to review the matter in question. This is an area where "Gracious Professionalism" is very important.
- <R114> At the time of inspection, the ROBOT must be presented with **all** MECHANISMS (including **all** COMPONENTS of each MECHANISM) **and configurations** that will be used on the ROBOT during the entire competition event. It is acceptable, however, for a ROBOT to play MATCHES with a **subset** of the MECHANISMS that were present during inspection. Only MECHANISMS that were present during the inspection may be added, removed or reconfigured between MATCHES. If subsets of MECHANISMS are changed between MATCHES, the reconfigured ROBOT must still meet all inspection criteria.
- <R115> If a ROBOT is rejected by inspectors due to a safety issue or concern related to the team's method of storing energy (see Rule <R01>), the concerned items must be disabled or removed from the ROBOT before it can compete in a MATCH. The team bears the burden of proof that such a rejection is not valid. Teams should be prepared to provide justifiable test data or calculations during inspection to support their design.
- <R116> *FIRST* Officials may randomly re-inspect ROBOTS participating in competition MATCHES to assure compliance with the rules.

### 8.4 PARTS USE FLOWCHART

